

Sigma Delta Vaporizer



The Delta vaporizer delivers accurate concentrations under varying conditions of flow rate and temperature, particularly at low flow

- ◆ Service Free*
- ◆ Selectatec®, Drager Plug-In®, North American Drager, Cagemount
- ◆ Superb performance, particularly at low flows
- ◆ Halothane, Enflurane, Isoflurane, Sevoflurane
- ◆ Keyed Filler, Quik Fil®, or Pour fill
- ◆ Low Body Weight
- ◆ 'Life-Care' or optional 'Life-Care Plus' Warranty and Customer Care scheme

Partnership for Life

Vaporizer Type	Halothane 4% 5% 8% Filler Type		Enflurane 5% 7% Filler Type		Isoflurane 5% Filler Type		Sevoflurane 8% Filler Type		
	Pour fill	Keyed Filler	Pour fill	Keyed Filler	Pour fill	Keyed Filler	Pour fill	Keyed Filler	Quik Fil®
	Selectatec® Compatible with Interlock	✓	✓	✓	✓	✓	✓	✓	✓
Drager Plug-In® Interlock Compatible	✓	✓	✓	✓	✓	✓	✓	✓	✓
Cagemount Taper 23 mm	✓	✓	✓	✓	✓	✓	✓	✓	✓
North American Drager	✓	✓	✓	✓	✓	✓	✓	✓	✓
Selectatec Compatible	✓	✓	✓	✓	✓	✓	✓	✓	✓

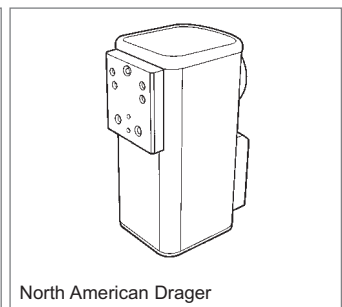
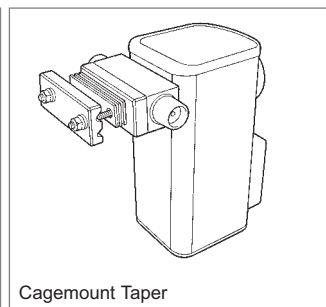
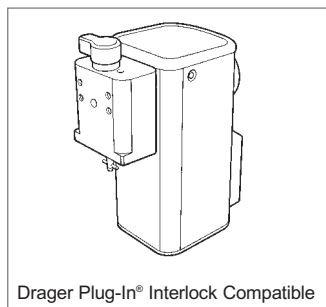
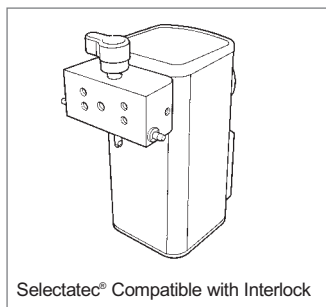

Life-Care

Life-Care is designed to give our customers after-sales peace of mind. 'Life-Care' consists of our comprehensive standard warranty and after-sales support package. 'Life-Care Plus' allows customers to purchase additional services and warranties to meet their particular needs.

For further details, please contact your Penlon Sales or Service Representative.

Technical Specification

Physical	
Weight	Approximate weight 5 kg
Capacity	Volume at MAX mark: 250 ml nominal Volume at MIN mark: 35 ±10 ml
Note	After draining, approximately 60 ±10 ml of liquid is retained by the wick
Flow Range	Operating flow range: 0.2 to 15 litres / min
Temperature Range	Operating temperature range: 15 to 35°C (58 to 95°F)
Size	
Cagemount Dimensions	219 x 133 x 158 mm (H x W x D)
Selectatec® Compatible with Interlock Dimensions	242 x 120 x 190 mm (H x W x D)
Drager Plug-In® Compatible Dimensions	242 x 100 x 190 mm (H x W x D)

Typical Performance Graph

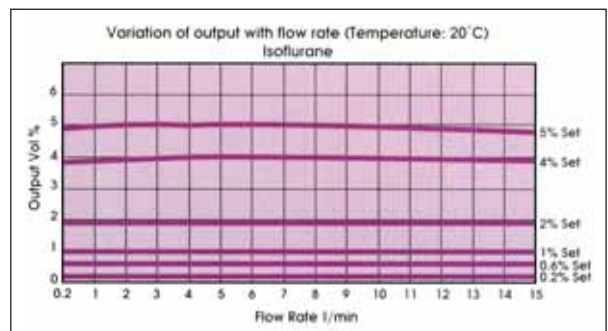

*Presumes ten year product life requiring no preventive maintenance service. It is recommended that a service is carried out at ten years. Halothane Vaporizers require a five year service.

Selectatec® is a Datex Ohmeda Trademark, Plug in® is a Drager Trademark

Partnership for Life

Penlon's philosophy embraces commitment to a successful, long term relationship with all our customers



Penlon Limited, Abingdon Science Park, Barton Lane, Abingdon, OX14 3PH UK

UK
Tel: 01235 547036
Fax: 01235 547023
E-mail: uksales@penlon.co.uk

International
Tel: +44 1235 547001
Fax: +44 1235 547021
E-mail: export@penlon.co.uk



Penlon Limited reserves the right to change technical specification without prior notice.

© 2008 Penlon Limited

Penlon Limited is a Member of the InterMed Group